

FLASHINGS

Flashings are made for particular applications and locations on the roof, with variations to suit the specific profile being used.

Industrial and commercial flashings tend to be functional more than aesthetic, and **Safintra** makes a range of standard flashings which are suitable for this purpose.

Residential flashings however, usually have an important aesthetic role which necessitates that they are designed for the structure in question.

Safintra is able to produce most custom designed flashings for residential and other applications-

Flashings are usually made in the same material as the roof, for colour matching. **Safintra** flashings are offered in Aluminium-Zinc coated steel and Aluminium. All counter flashings **should be sealed with silicone - not cement.**

Please speak to **Safintra** office for further guidance and technical assistance.

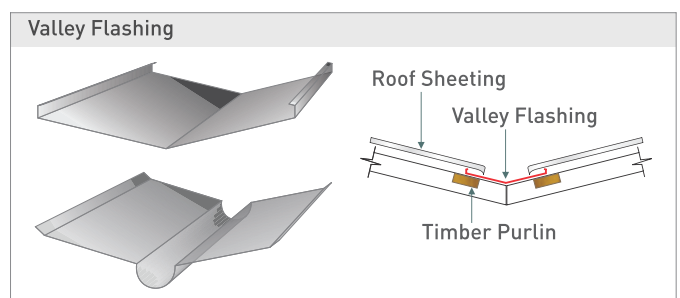
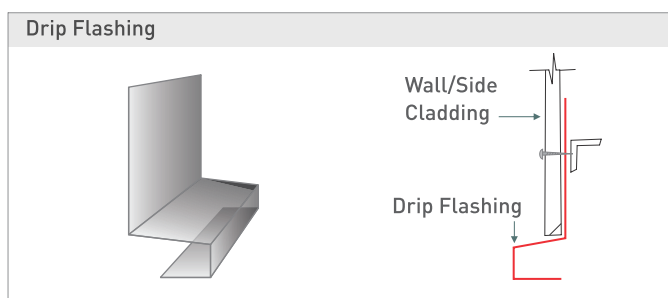
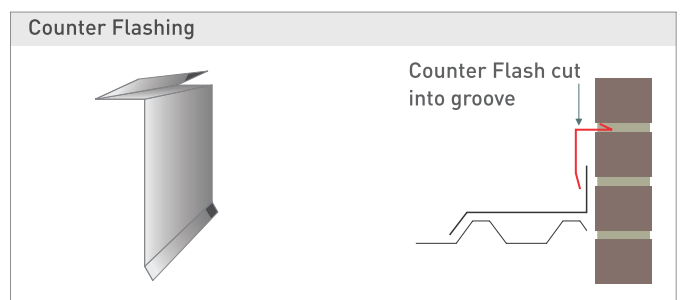
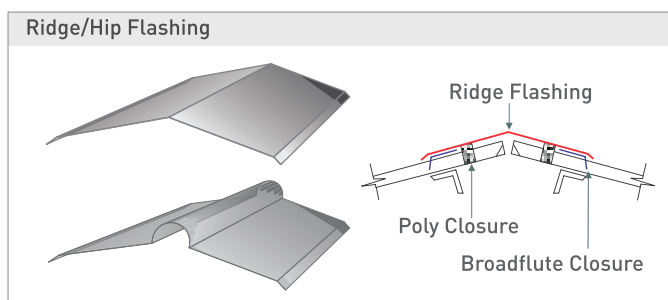
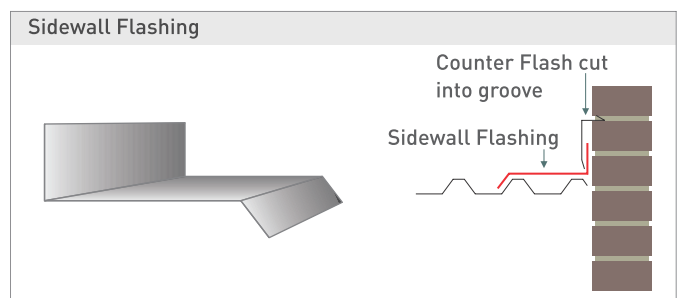
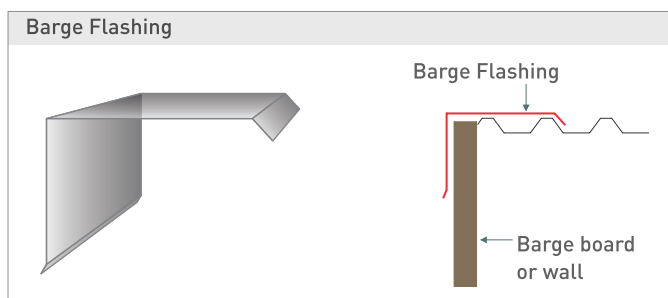
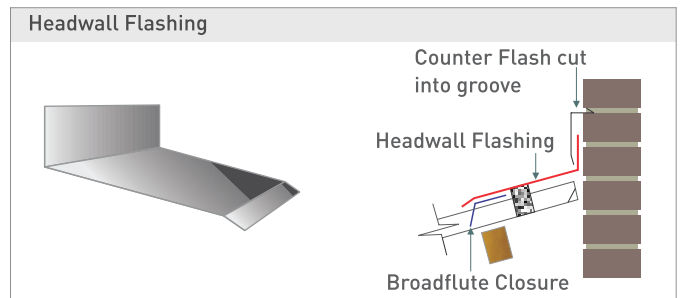
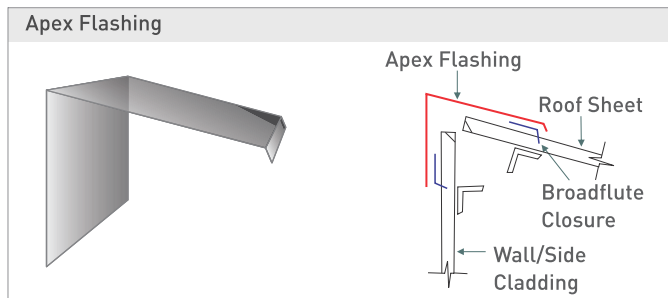

A member of the

